

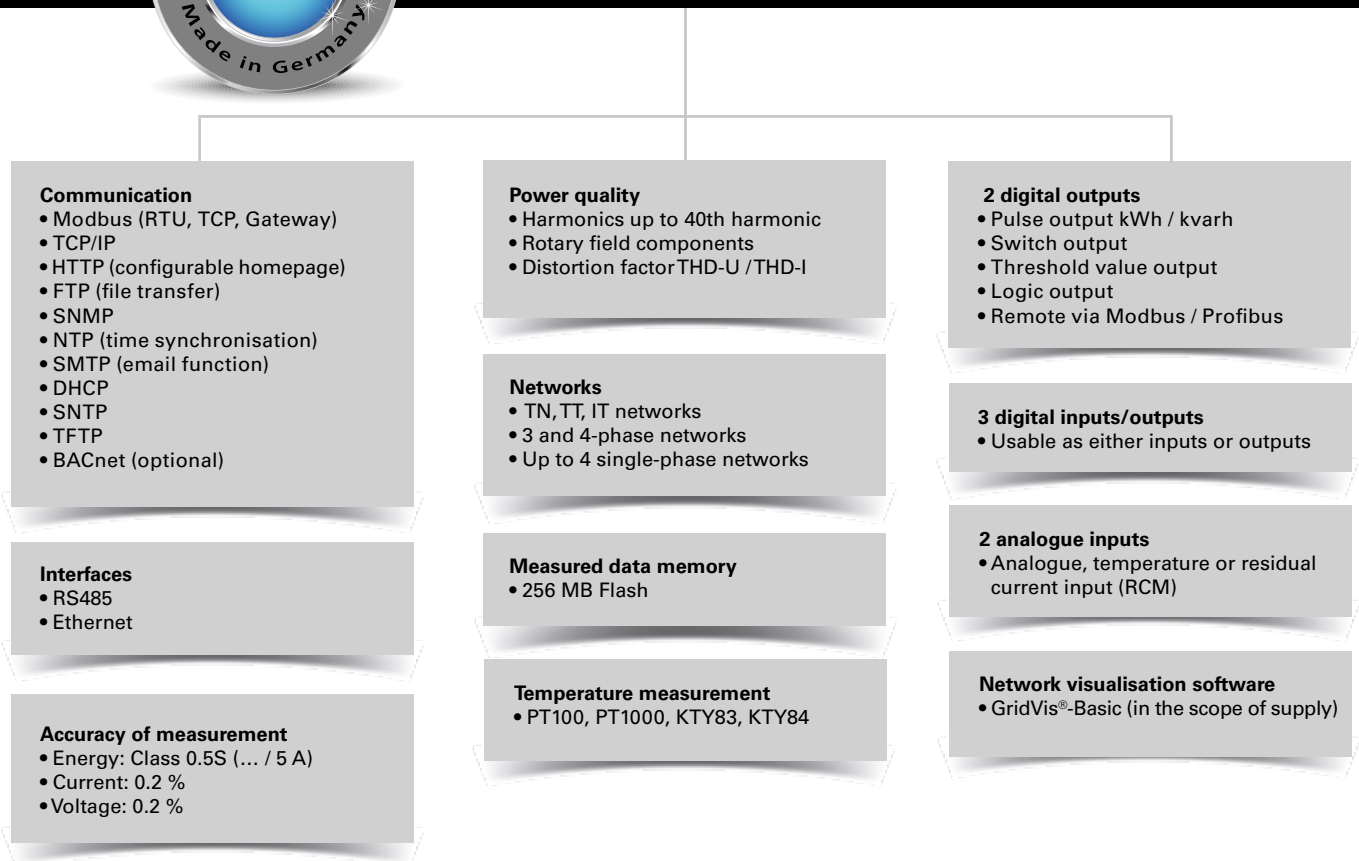

UMG 96RM-E – Power analyser with Ethernet and RCM

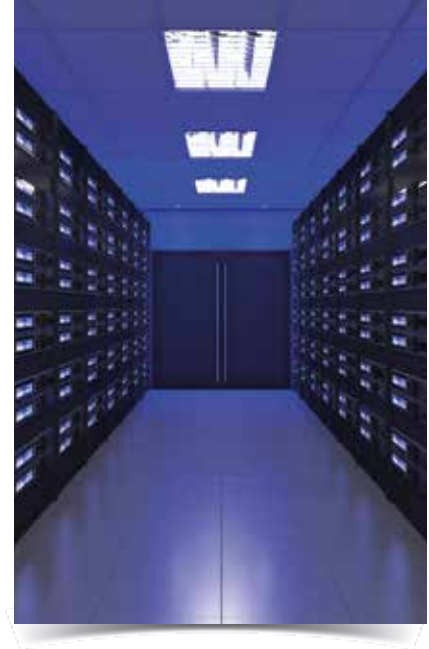



Areas of application



- Measurement, monitoring and checking of electrical characteristics in energy distribution systems
- Recording of load profiles in energy management systems (e.g. ISO 50001)
- Acquisition of the energy consumption for cost centre analysis
- Measured value transducer for building management systems or PLC (Modbus)
- Monitoring of power quality characteristics, e.g. harmonics up to 40th harmonic
- Residual current monitoring (RCM)

Main features

Universal meter

- Operating current monitoring for general electrical parameters
- High transparency through a multi-stage and scalable measurement system in the field of energy measurement
- Acquisition of events through continuous measurement with 200 ms high resolution



RCM device

- Continuous monitoring of residual currents (Residual Current Monitor, RCM)
- Alarming in case a preset threshold fault current reached
- Near-realtime reactions for triggering countermeasures
- Permanent RCM measurement for systems in permanent operation without the opportunity to switch off

Energy measurement device

- Continuous acquisition of the energy data and load profiles
- Essential both in relation to energy efficiency and for the safe design of power distribution systems



Harmonics analyser / event recorder

- Analysis of individual harmonics for current and voltage
- Prevention of production downtimes
- Significantly longer service life for equipment
- Rapid identification and analysis of power quality fluctuations by means of user-friendly tools (GridVis®)

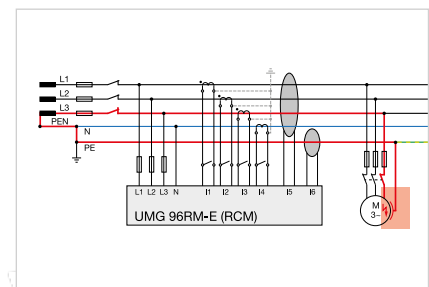

Fig.: UMG 96RM-E with residual current monitoring via measuring inputs I5 / I6

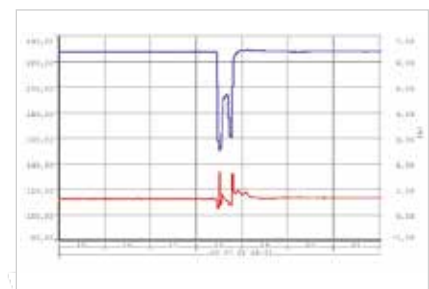

Fig.: Event logger: Voltage dip in the low voltage distribution system

7 Tariffs

Extensive selection of tariffs

- 7 tariffs each for effective energy (consumption, delivery and without backstop)
- 7 tariffs each for reactive energy (inductive, capacitive and without backstop)
- 7 tariffs for apparent energy
- L1, L2 and L3, for each phase

Highest possible degree of reliability

- Continuous leakage current measurement
- Historical data: Long-term monitoring of the residual current allows changes to be identified in good time, e.g. insulation faults
- Time characteristics: Recognition of time relationships
- Prevention of neutral conductor carryover
- RCM threshold values can be optimized for each individual case: Fixed, dynamic and stepped RCM threshold value
- Monitoring of the CGP (central ground point) and the sub-distribution panels

Analysis of fault current events

- Event list with time stamp and values
- Presentation of fault currents with characteristic and duration
- Reproduction of phase currents during the fault current surge
- Presentation of the phase voltages during the fault current surge

Analysis of the harmonic fault current components

- Frequencies of the fault currents (fault type)
- Current peaks of the individual frequency components in A and %
- Harmonics analysis up to 40th harmonic
- Maximum values with real-time bar display

Digital IOs

- Extensive configuration of IOs for intelligent integration, alarm and control tasks

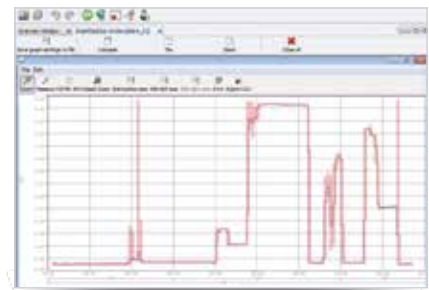

Fig.: Continuous leakage current measurement

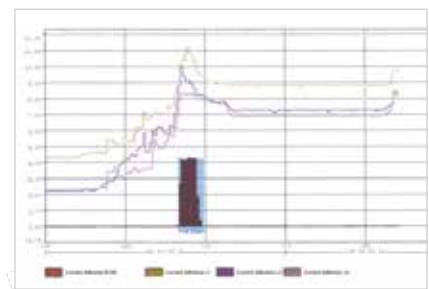

Fig.: Analysis of fault current events

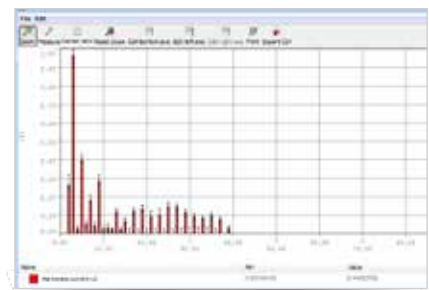

Fig.: Analysis of the harmonic fault current components



Ethernet (TCP/IP)- / Homepage- / Ethernet-Modbus gateway functionality

- Simple integration into the network
- More rapid and reliable data transfer
- Modern homepage
- World-wide access to measured values by means of standard web browsers via the device's inbuilt homepage
- Access to measurement data via various channels
- Reliable saving of measurement data possible over a very long periods of time in the 256 MByte measurement data memory
- Connection of Modbus slave devices via Ethernet-Modbus gateway



Fig.: Ethernet-Modbus gateway functionality



Measuring device homepage

- Webserver on the measuring device, i.e. device's own homepage
- Remote operation of the device display via the homepage
- Comprehensive measurement data incl. PQ
- Online data directly available via the homepage, historic data optional via the APP measured value monitor, 51.00.246

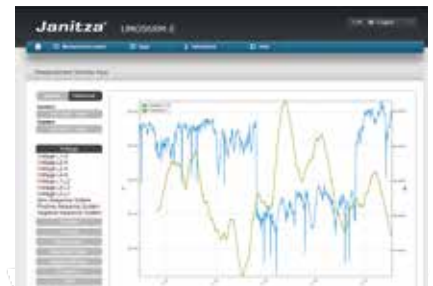
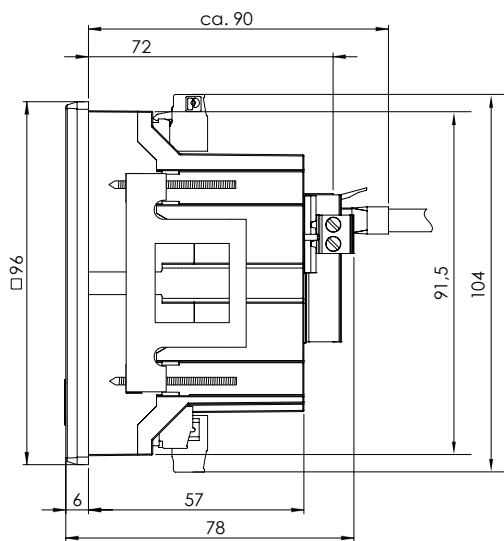

Fig.: Illustration of the online data via the device's inbuilt homepage



Dimension diagrams

All dimensions in mm



Side view

Cut out: 92^{+0,8} x 92^{+0,8} mm

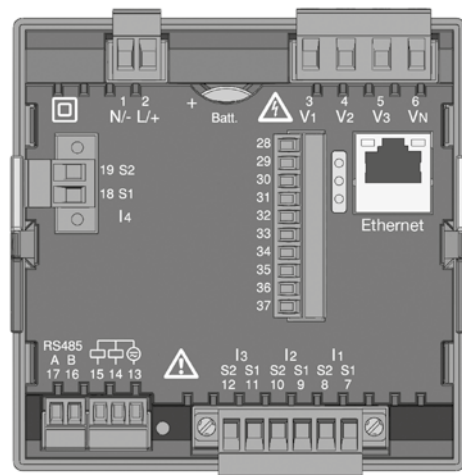

Rear view



Typical connection

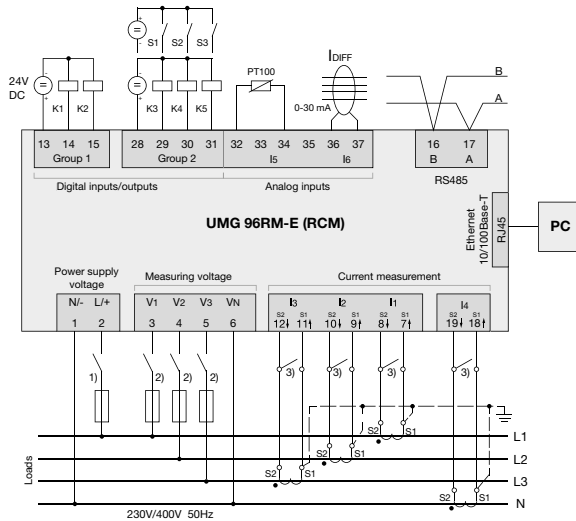

Fig.: Connection example with temperature and residual current measurement



Device overview and technical data

	UMG 96RM-E*1
Item number (90–277 V AC / 90–250 V DC)	52.22.062
Item number (24–90 V AC / 24–90 V DC)	52.22.063
General	
Use in low and medium voltage networks	•
Accuracy voltage measurement	0.2 %
Accuracy current measurement	0.2 %
Accuracy active energy (kWh, .../5 A)	Class 0.5S
Number of measurement points per period	426
Uninterrupted measurement	•
RMS - momentary value	
Current, voltage, frequency	•
Active, reactive and apparent power / total and per phase	•
Power factor / total and per phase	•
Energy measurement	
Active, reactive and apparent energy [L1, L2, L3, Σ L1–L3]	•
Number of tariffs	14
Recording of the mean values	
Voltage, current / actual and maximum	•
Active, reactive and apparent power / actual and maximum	•
Frequency / actual and maximum	•
Demand calculation mode (bi-metallic function) / thermal	•

Comment:

For detailed technical information please refer to the operation manual and the Modbus address list.

• = included - = not included

*1 Inclusive UL certification.

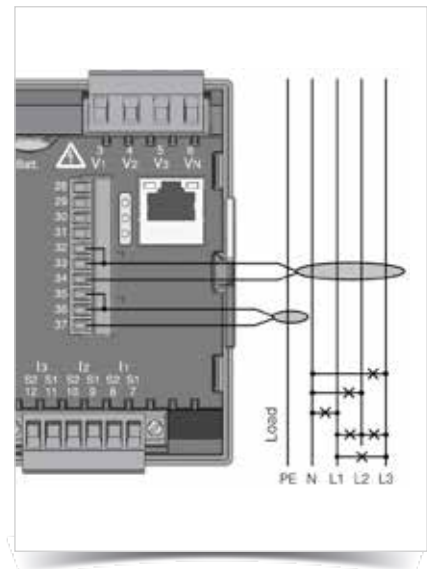

Fig.: Connection example residual current measurement and PE monitoring

Other measurements	
Operating hours measurement	•
Clock	•
Power quality measurements	
Harmonics per order / current and voltage	1st – 40th
Distortion factor THD-U in %	•
Distortion factor THD-I in %	•
Rotary field indication	•
Current and voltage, positive, zero and negative sequence component	•
Error / event recorder function	•
Under and overvoltage recording	•
Measured data recording	
Memory (Flash)	256 MB
Average, minimum, maximum values	•
Current measurement channel	4 (+2)
Alarm messages	•
Time stamp	•
Time basis average value	freely user-defined
RMS averaging, arithmetic	•
Displays and inputs / outputs	
LCD display (with backlighting), 2 buttons	•
Digital outputs (as switch or pulse output)	2
Digital inputs and outputs (selectable)	3
Analogue inputs (RCM, temperature, analogue)	2
Voltage inputs	L1, L2, L3 + N
Password protection	•
Communication	
Interfaces	
RS485: 9.6 – 115.2 kbps (Screw-type terminal)	•
Ethernet 10/100 Base-TX (RJ-45 socket)	•
Protocols	
Modbus RTU	•
Modbus TCP/IP	•
Modbus RTU over Ethernet	•
Modbus Gateway for Master-Slave configuration	•
HTTP (homepage configurable)	•
SMTP (email)	•
NTP (time synchronisation)	•
TFTP	•
FTP (File-Transfer)	•
SNMP	•
DHCP	•
BACnet (optional)	•
ICMP (Ping)	•
Software GridVis®-Basic^{*2}	
Online and historic graphs	•
Databases (Janitza DB, Derby DB); MySQL, MS SQL with higher GridVis® versions)	•
Manual reports (energy, power quality)	•
Topology views	•
Manual read-out of the measuring devices	•
Graph sets	•
Programming / threshold values / alarm management	
Comparator (5 Groups with 10 comparators each)	•
Comprehensive adjustment options for RCM	•

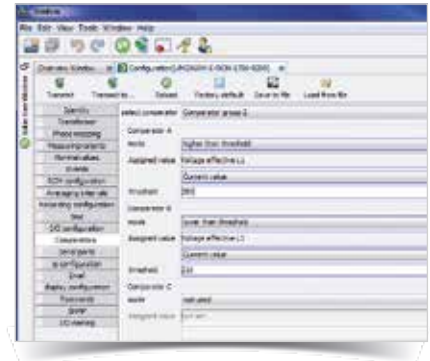

Fig.: GridVis® software, configuration menu

Comment:
For detailed technical information please refer to the operation manual and the Modbus address list.

• = included - = not included

*² Optional additional functions with the packages GridVis®-Professional, GridVis®-Service and GridVis®-Ultimate.

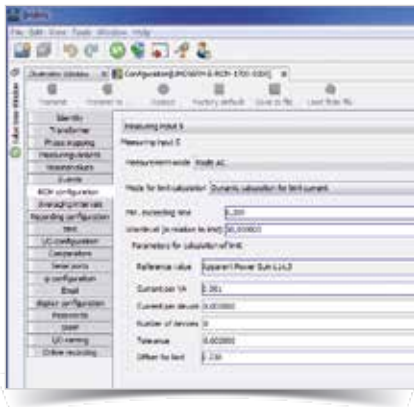

Fig.: RCM configuration, e.g. dynamic threshold value formation, for load-dependent threshold value adaptation



Fig.: Summation current transformer for the acquisition of residual currents. Wide range of different configurations and sizes allow use in almost all applications

Technical data	
Type of measurement	Constant true RMS Up to 40th harmonic
Nominal voltage, three-phase, 4-conductor (L-N, L-L)	277 / 480 V AC
Nominal voltage, three-phase, 3-conductor (L-L)	480 V AC
Measurement in quadrants	4
Networks	TN, TT, IT
Measured voltage input	
Overvoltage category	300 V CAT III
Measured range, voltage L-N, AC (without potential transformer)	10 ... 300 Vrms
Measured range, voltage L-L, AC (without potential transformer)	18 ... 520 Vrms
Resolution	0.01 V
Impedance	4 MOhm / phase
Frequency measuring range	45 ... 65 Hz
Power consumption	approx. 0.1 VA
Sampling frequency per channel (50 / 60 Hz)	21.33 / 25.6 kHz
Measured current input	
Rated current	1 / 5 A
Resolution	0.1 mA
Measurement range	0.001 ... 6 Amps
Overvoltage category	300 V CAT II
Measurement surge voltage	2 kV
Power consumption	approx. 0.2 VA (Ri = 5 mOhm)
Overload for 1 sec.	120 A (sinusoidal)
Sampling frequency per channel (50 / 60 Hz)	21.33 / 25.6 kHz
Residual current input	
Analogue inputs	2 (for residual current or temperature measurement)
Measurement range, residual current input*3	0.05 ... 30 mA
Digital outputs	
Switching voltage	max. 60 V DC, 33 V AC
Switching current	max. 50 mA Eff AC / DC
Response time	10 / 12 periods + 10 ms
Pulse output (energy pulse)	max. 50 Hz
Maximum cable length	up to 30 m unshielded, from 30 m screened
Mechanical properties	
Weight	approx. 370 g
Device dimensions in mm (H x W x D)*4	96 x 96 x 78
Battery	CR2032, 3 V, type Lithium
Protection class per EN 60529	Front: IP40; Back: IP20
Assembly per IEC EN 60999-1 / DIN EN 50022	Front panel installation
Cable cross section	
Supply voltage	0.2 to 2.5 mm ²
Current measurement	0.2 to 2.5 mm ²
Voltage measurement	0.08 to 4.0 mm ²
Environmental conditions	
Temperature range	Operation: K55 (-10 ... +70 °C)
Relative humidity	Operation: 0 to 75 % RH
Operating height	0 ... 2,000 m above sea level
Degree of pollution	2
Installation position	user-defined
Electromagnetic compatibility	
Electromagnetic compatibility of electrical equipment	Directive 2004/108/EC
Electrical appliances for application within particular voltage limits	Directive 2006/95/EC

Comment:

For detailed technical information please refer to the operation manual and the Modbus address list.

• = included - = not included

*3 Example of residual current input 30 mA with 600/1 residual current transformer: 600 x 30 mA = 18,000 mA

*4 Accurate device dimensions can be found in the operation manual.

Equipment safety	
Safety requirements for electrical equipment for measurement, regulation, control and laboratory use – Part 1: General requirements	IEC/EN 61010-1
Part 2-030: Particular requirements for testing and measuring circuits	IEC/EN 61010-2-030
Noise immunity	
Class A: Industrial environment	IEC/EN 61326-1
Electrostatic discharge	IEC/EN 61000-4-2
Voltage dips	IEC/EN 61000-4-11
Emissions	
Class B: Residential environment	IEC/EN 61326-1
Radio disturbanc voltage strength 30 – 1000 MHz	IEC/CISPR11/EN 55011
Radiated interference voltage 0.15 – 30 MHz	IEC/CISPR11/EN 55011
Safety	
Europe	CE labelling
Firmware	
Firmware update	Update via GridVis® software. Firmware download (free of charge) from the website: http://www.janitza.com

Comment:
For detailed technical information please refer to the operation manual and the Modbus address list.

• = included - = not included

