

# CAPTURE EVERY DETAIL



## WaveRunner 8000HD



**350 MHz - 2 GHz**  
**High Definition Oscilloscopes**

- **Highest Resolution** HD4096 Technology, 12 bits all the time
- **More Channels** More flexibility
- **Longest Memory** 5 Gpt records with simple navigation

# Highest Resolution



High Signal to Noise Input Amplifiers

**HD**  
4096

High Sample Rate 12-bit ADC's

Low Noise System Architecture

**12 bits all the time  
16x closer to perfect**

- Clean, crisp waveforms
- More signal details
- Unmatched measurement precision

# More Channels



**More channels, more flexibility**

- 8 channels is better than 4
- 16 channels with OscilloSYNC
- No analog/digital channel tradeoffs

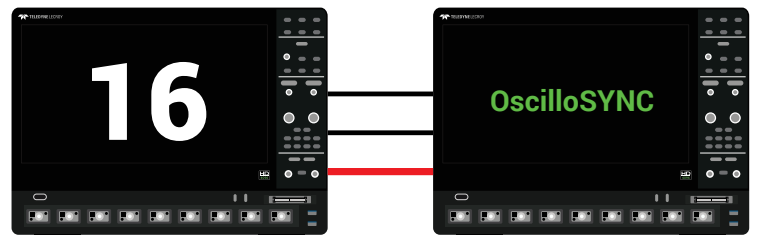

# Longest Memory

**5 Gpts records with simple navigation - no compromises**

- 5 Gpts - fast and responsive
- Simple navigation with timebase adjust or zoom traces
- No compromises - long captures at full sample rate

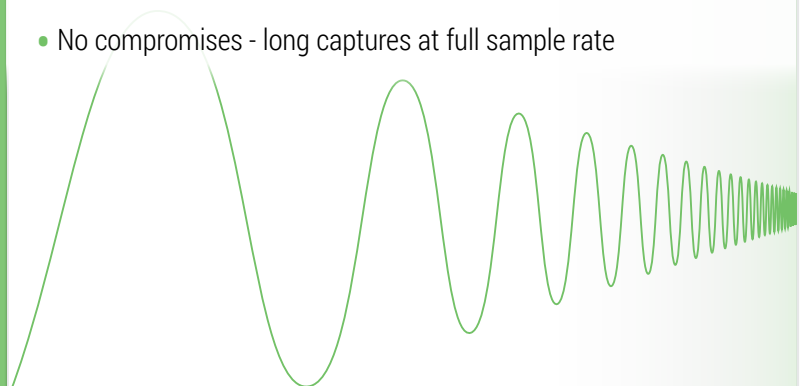

# Capture Every Detail



Providing **12 bits all the time**,  
**more channels** than any other oscilloscope,  
and **long memory** without tradeoffs – the  
**WaveRunner 8000HD** captures every detail.

The only **8 channel, 12 bit, 2 GHz** oscilloscope



WaveRunner 8000HD

# HD4096 TECHNOLOGY - 16X CLOSER TO PERFECT

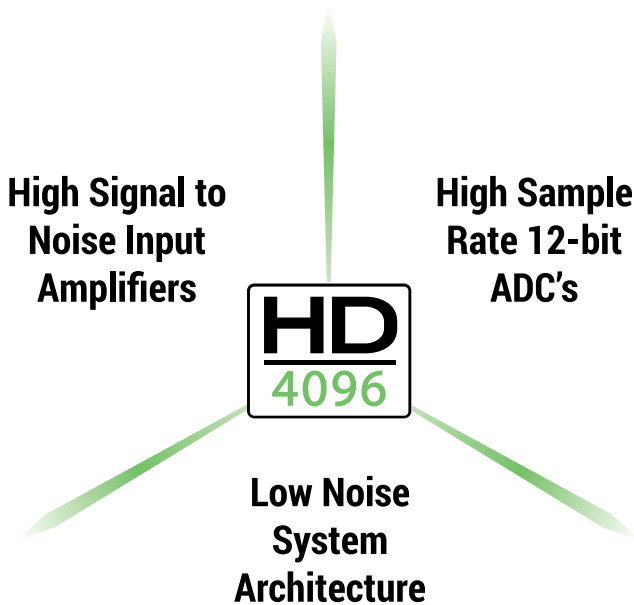

Teledyne LeCroy high definition 12-bit oscilloscopes use unique HD4096 technology to provide superior and uncompromised measurement performance:

- 12-bit ADCs with high sample rates
- High signal-to-noise amplifiers
- Low noise system architecture (to 2 GHz)

Oscilloscopes with HD4096 technology have higher resolution than conventional 8-bit oscilloscopes (4096 vs. 256 vertical levels) and low noise for uncompromised measurement performance. The 12-bit ADCs support capture of fast signals at oscilloscope bandwidth ratings up to 2 GHz, while Enhanced Sample Rate to 10 GS/s ensures the highest measurement accuracy and precision. The high performance input amplifiers deliver pristine signal fidelity, and the low-noise system architecture provides an ideal signal path to ensure that signal details are delivered accurately to the oscilloscope display – 16x closer to perfect.

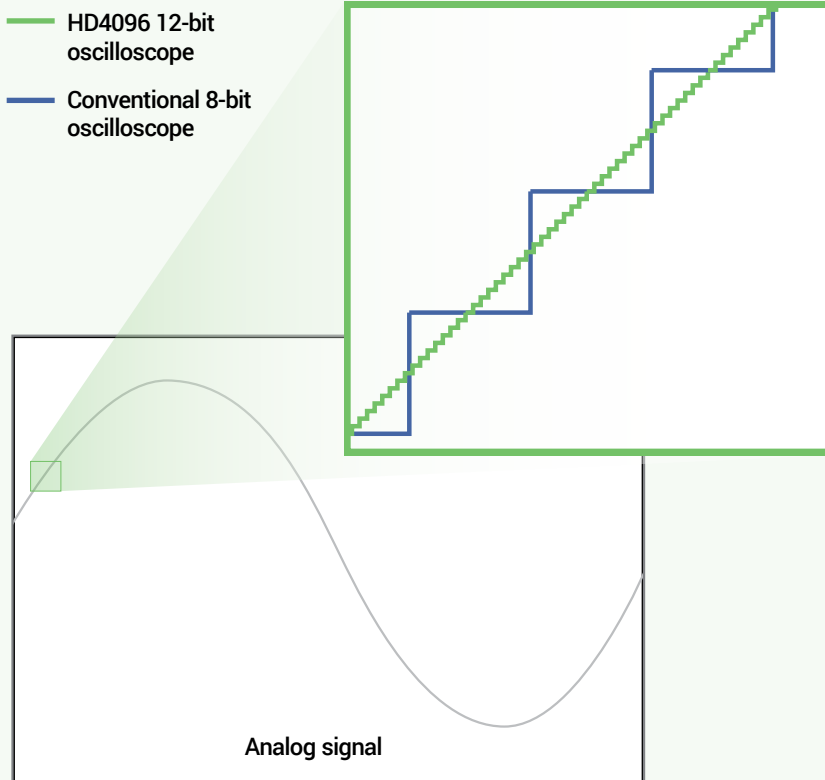

## 16x Closer to Perfect

### 16x more resolution

HD4096 technology provides 12 bits of vertical resolution – 16x more resolution than conventional 8-bit oscilloscopes. The 4096 discrete vertical levels reduce the quantization error compared to 256 vertical levels. This improves the accuracy and precision of the signal capture and increases measurement confidence.

# EXPERIENCE THE DIFFERENCE



Experience HD4096 accuracy, detail and precision and never use an 8-bit oscilloscope again. Whether the application is general purpose design and debug, high precision analog sensors, power electronics, automotive electronics, mechatronics or other specialized applications, the HD4096 technology provides unsurpassed confidence and measurement capabilities.

## Clean, crisp waveforms

When compared to waveforms acquired and displayed using conventional 8-bit oscilloscopes, waveforms captured with HD4096 12-bit technology are dramatically crisper and cleaner, and are displayed more accurately. Once you see a waveform acquired with HD4096 technology, you will not want to go back to using a conventional 8-bit oscilloscope.

## More signal details

16x more resolution provides more signal detail. This is especially helpful for analyzing wide dynamic range signals where very small amplitude signal details must be viewed. 12-bit acquisitions combined with the oscilloscope's vertical and horizontal zoom capabilities provide unparalleled insight into system behaviors and problems.

## Unmatched measurement precision

HD4096 technology delivers measurement precision several times better than conventional 8-bit oscilloscopes. Higher oscilloscope measurement precision results in better ability to assess corner cases and design margins, perform root cause analysis, and create the best possible solution for any discovered design issue.

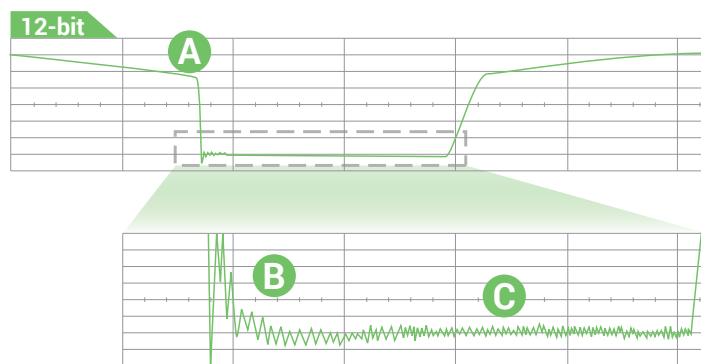
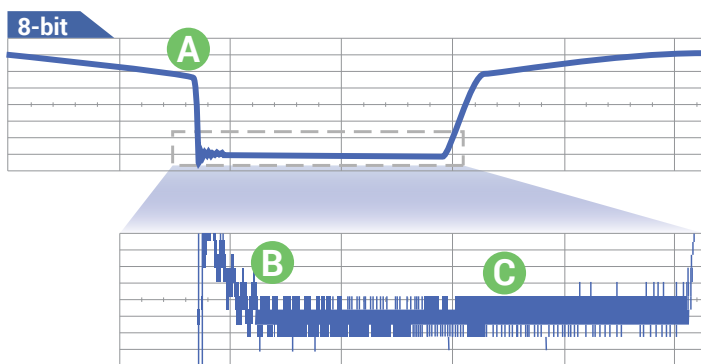

- A Clean, crisp waveforms** | Thin traces show the actual waveform with minimal noise interference.
- B More signal details** | Waveform details can now be clearly seen on an HD4096 12-bit oscilloscope.
- C Unmatched measurement precision** | Measurements are more precise and not affected by quantization noise.



The WaveRunner 8000HD is the only oscilloscope to offer 8 analog channels and 16 digital channels, allow synchronization of two 8-channel systems, and not penalize you for using a digital channel.

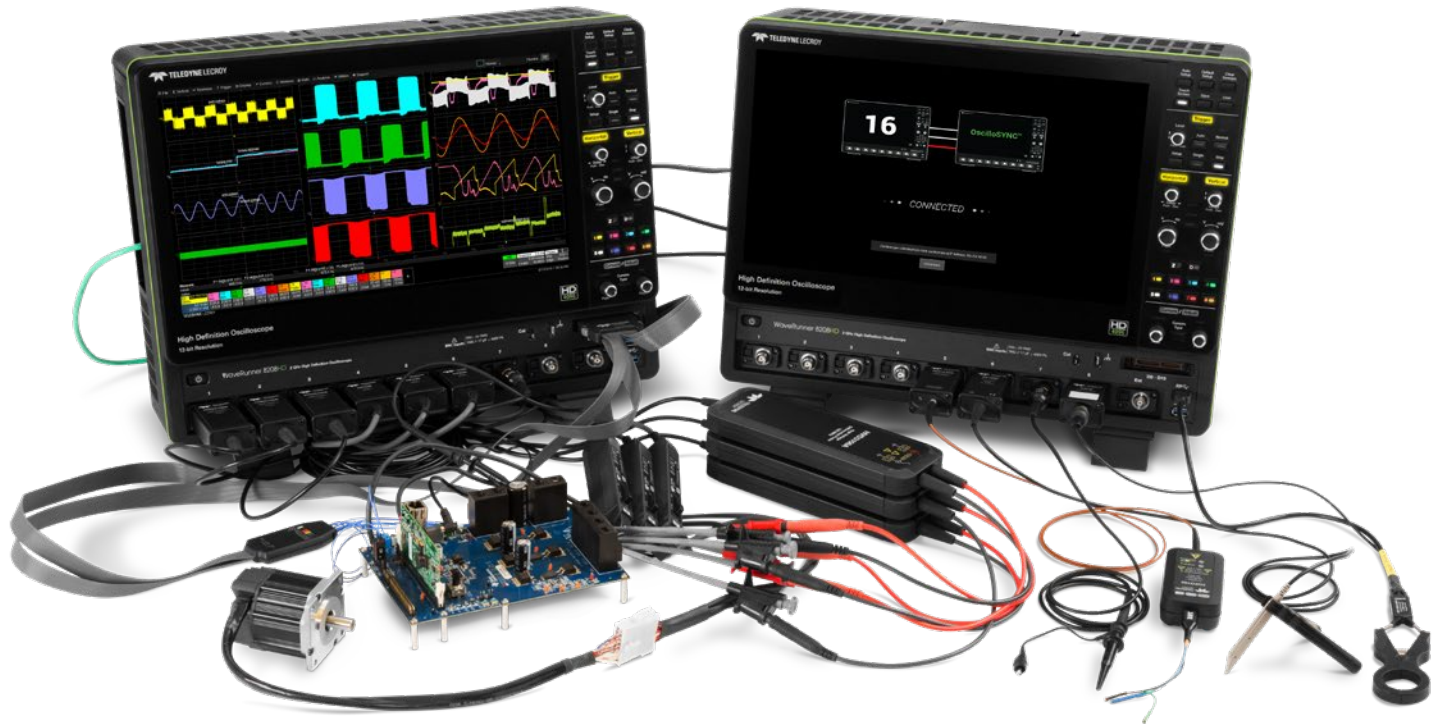

## 8 channels is better than 4

Twice the number of channels for much less than twice the price of a four channel oscilloscope. Gain efficiency and productivity by analyzing more of your system at one time, and locate problems that would not be apparent with only four channels.

## 16 channels with OscilloSYNC™

View and control 16 analog channels on a single display with OscilloSYNC technology – just like having a single 16-channel acquisition system. Setup is incredibly easy with four simple steps.

## No analog/digital tradeoffs

All 8 analog and 16 digital channels are always available. Other oscilloscopes require that you trade a valuable analog channel in exchange for digital inputs. With Teledyne LeCroy, you always get all the channels you paid for.

The activation key can be downloaded at no charge from:  
[teledynelecroy.com/redeem/OscilloSYNC](http://teledynelecroy.com/redeem/OscilloSYNC)

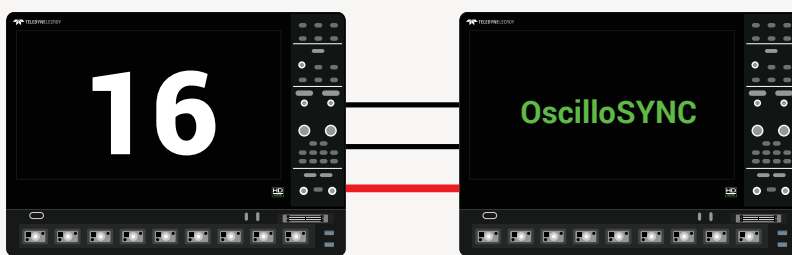

## OscilloSYNC Technology

- 1 - Connect Ref. In/Out terminals.
  - 2 - Connect Aux Out terminals.
  - 3 - Connect Ethernet ports.
  - 4 - Enter IP Address and press Connect.
- Acquire 16 channels on one display.

With up to 5 Gpts of acquisition memory, WaveRunner 8000HD 12-bit oscilloscopes capture long periods of time, yet maintain high sample rate for visibility into the smallest details.

## 5 Gpts - fast and responsive

WaveRunner 8000HD oscilloscopes contain a sophisticated acquisition and memory management architecture that makes 5 Gpt acquisitions fast and responsive. More memory means more visibility into system behavior.

## Simple navigation

Long memory and high sample rates capture both millisecond-scale trends and picosecond-scale glitches. WaveRunner 8000HD oscilloscopes are equipped with an advanced user interface that makes it easy to find features, navigate directly using timebase scale and position knobs, or set up zoom traces - whichever you prefer. Apply analysis tools easily to any type of trace.

## No compromise

WaveRunner 8000HD can acquire 500 ms of data at the full 10 GS/s sample rate - and always with 12 bits of resolution. Oscilloscopes with less memory require trading sample rate for acquisition time.



**WaveRunner 8000HD**  
5 Gpts @ 10 GS/s  
500 ms acquisition time

**Competitor**  
125 Mpts @ 6.25 GS/s  
20 ms acquisition time

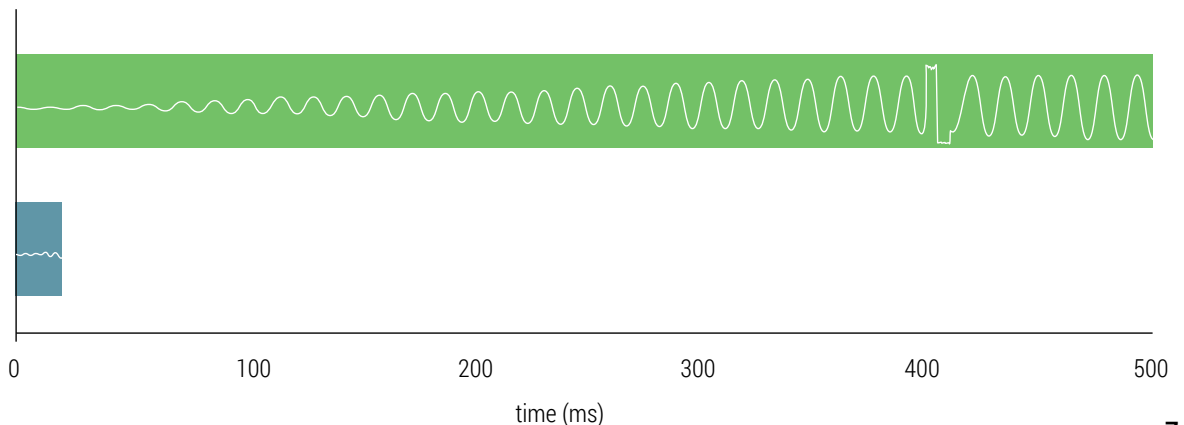



**WaveRunner 8000HD 12-bit oscilloscopes deliver 8 analog channels (16 with OscilloSYNC), 3-phase power analysis software, and high performance probes for inverter subsection, power system and control testing.**

### Static, Dynamic, Complete

Analyze short or long acquisitions. The mean value Numerics table summarizes static performance, while per-cycle Waveforms help you understand dynamic behaviors. Use Zoom+Gate to isolate and correlate power system behaviors to control system activity during time periods as short as a single device switching cycle.

### Comprehensive probing

HVD series high voltage differential probes have 65 dB CMRR at 1 MHz with 1% gain accuracy, the widest voltage ranges, and up to 6 kV common-mode rating. Connect current probes or use your own transducers with the programmable CA10 current sensor adapter to create a customized “probe”. HVFO fiber-optic probes are ideal for gate drive probing.

### Up to 16 analog channels

8 analog inputs at up to 2 GHz let you monitor an H-bridge’s four pairs of device output and gate drive input signals. Cascaded H-bridges may be easily monitored using 12 channels, with three additional channels for output voltage. WaveRunner 8000HD has enough channels for full 3-phase power section input/output and control section analysis.



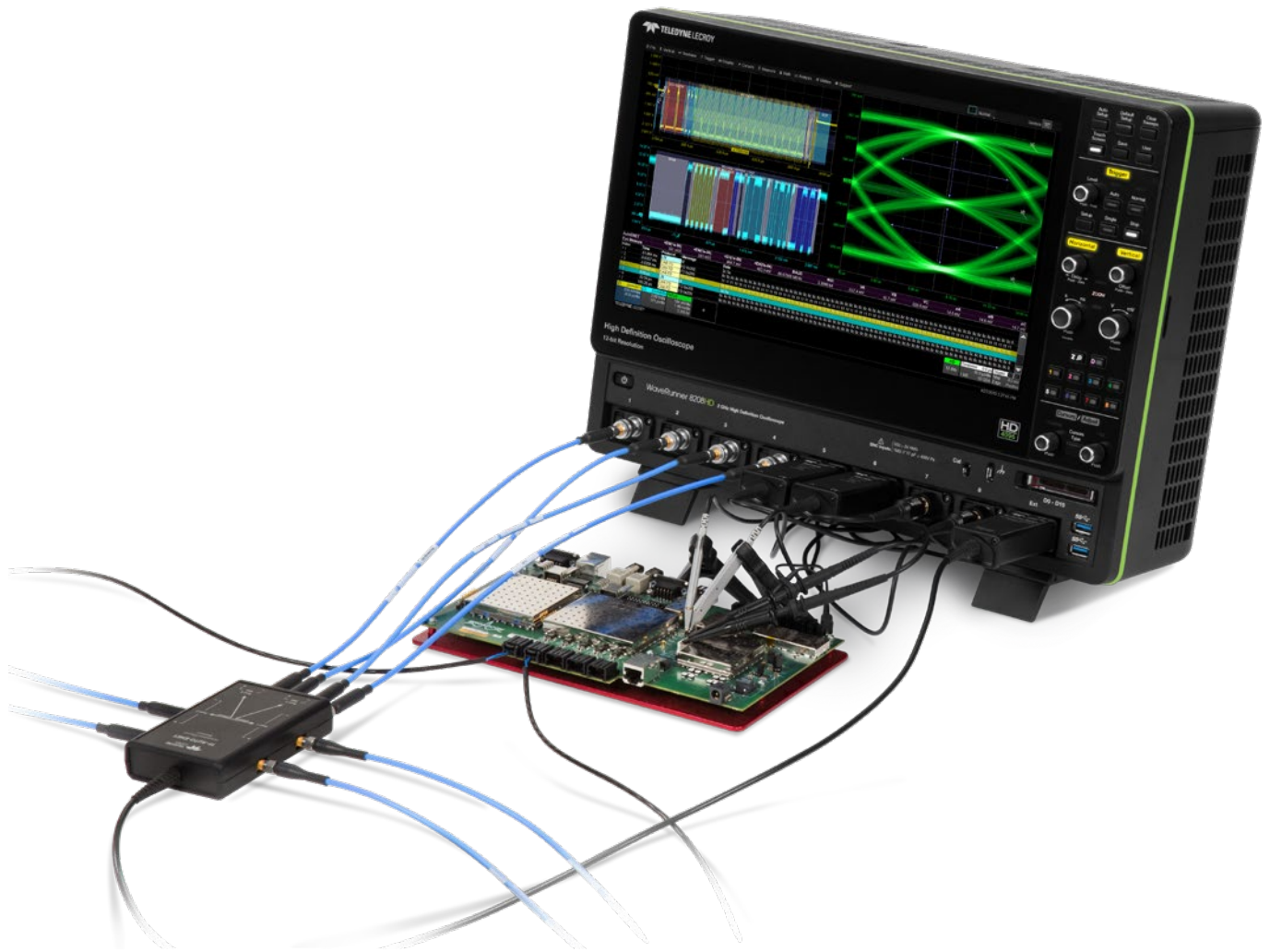

**WaveRunner 8000HD 12-bit oscilloscopes combine a high channel count, long memory, and wide range of validation and debug software to best address the specific test needs of the automotive industry.**

### Best vehicle bus debug tools

Unique capabilities that build on our legacy serial data trigger and decode provide the most complete debug and validation of automotive buses. Cover all aspects of physical layer Automotive Ethernet testing with compliance test software and a dedicated Automotive Ethernet debug toolkit.

### More channels for ECU debug

The flexibility of 8 12-bit analog channels and 16 digital channels make WaveRunner 8000HD the best way to analyze the array of analog, digital, and sensor signals in today's complex ECUs. Easily capture system startup behavior and perform causal analysis with 5 Gpt of memory.

### EMI/EMC pre-compliance test

12-bit resolution for spectral analysis provides more insight. Specialized EMC/EMI pulse parameters provide measurement flexibility. Support for all relevant electrical and magnetic field units of measure. Capability to measure sub-1 Hz magnetic field strengths.

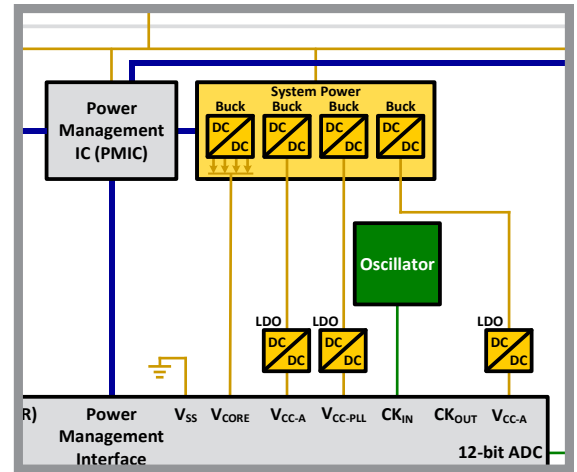

**WaveRunner 8000HD 12-bit oscilloscopes' high resolution, long memory and high channel count let you validate and debug all aspects of power supply, delivery and consumption - for complete confidence.**

### Accurate PDN measurements

Make sensitive measurements like rail collapse characterization with total confidence thanks to WaveRunner 8000HD's high dynamic range and 0.5% gain accuracy. Its HD4096 architecture means an exceptionally low noise floor, for easily pinpointing noise sources.

### Specialized power probes

Combine WaveRunner 8000HD with the RP4030 4 GHz Power Rail Probe for unsurpassed insight into PDN behavior. The variety of probe tips ensures easy connectivity, and its low loading characteristics minimize disruption to the device under test.

### Power sequencing

8 analog channels with 12-bit resolution and high offset capability give full visibility into power sequencing behavior - with 16 digital inputs available to decode and trigger on SPMI and other power management interfaces. Up to 5 Gpts of acquisition memory to capture every detail.

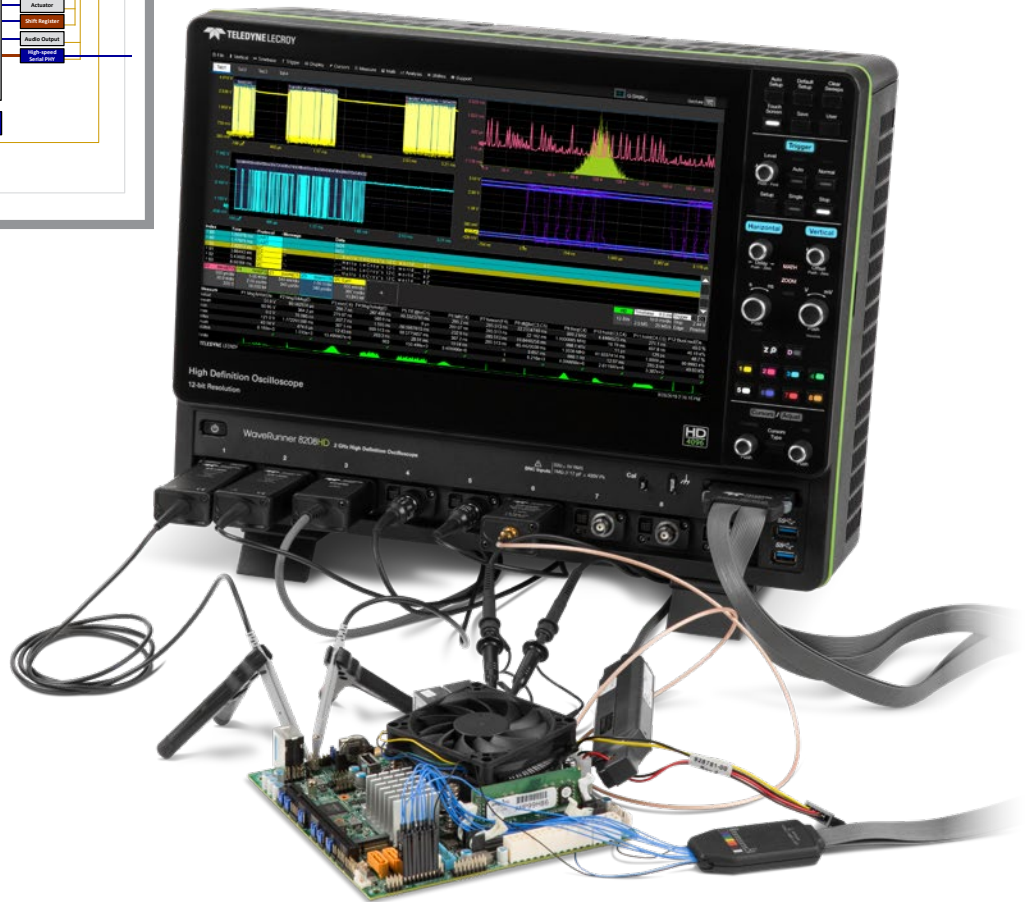
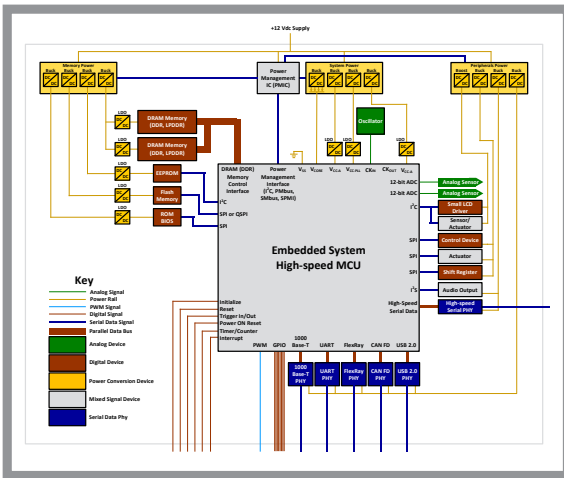

**WaveRunner 8000HD 12-bit oscilloscopes acquire the longest records at the highest resolution for the most comprehensive deeply embedded computing system analysis (analog, digital, serial data, and sensor).**

### Powerful, deep toolbox

More standard math, measure, pass/fail and other tools than other oscilloscopes provide faster and more complete insight into circuit problems. Many additional application packages are optionally available to enhance understanding.

### 8 channels with long captures

8 channels with 12-bit resolution make the WaveRunner 8000HD the best performing oscilloscope for embedded systems testing, specifically those with sensor signals. 5 Gpts of memory captures every detail when performing causal analysis.

### Comprehensive probe offering

A wide selection of low voltage, high voltage and current probes accurately measures every signal in your circuit. Additional probe adapters easily integrate third-party probes.



## Key Attributes

1. 15.6" 1900 x 1080 capacitive touchscreen display
2. 8 analog input channels
3. ProBus input supports every Teledyne LeCroy probe
4. MAUI with OneTouch user interface for intuitive and efficient operation
5. Q-Scape multi-tab display architecture
6. Up to 5 Gpts of acquisition memory
7. HD4096 technology - 12 bits all the time
8. Buttons/indicators color-coded to associated waveform on display
9. Use cursors and adjust settings without opening a menu
10. Mixed Signal capability with 16 integrated digital channels
11. 6 USB 3.1 ports (2 front, 4 side)
12. HDMI and DisplayPort - supports UHD (4096 x 2304) external monitor
13. Removable SSD (standard)
14. View 16 channels on one display with OscilloSYNC
15. Reference Clock Input/Output for connecting to other equipment
16. USBTMC over USB 3.1 for fast data offload





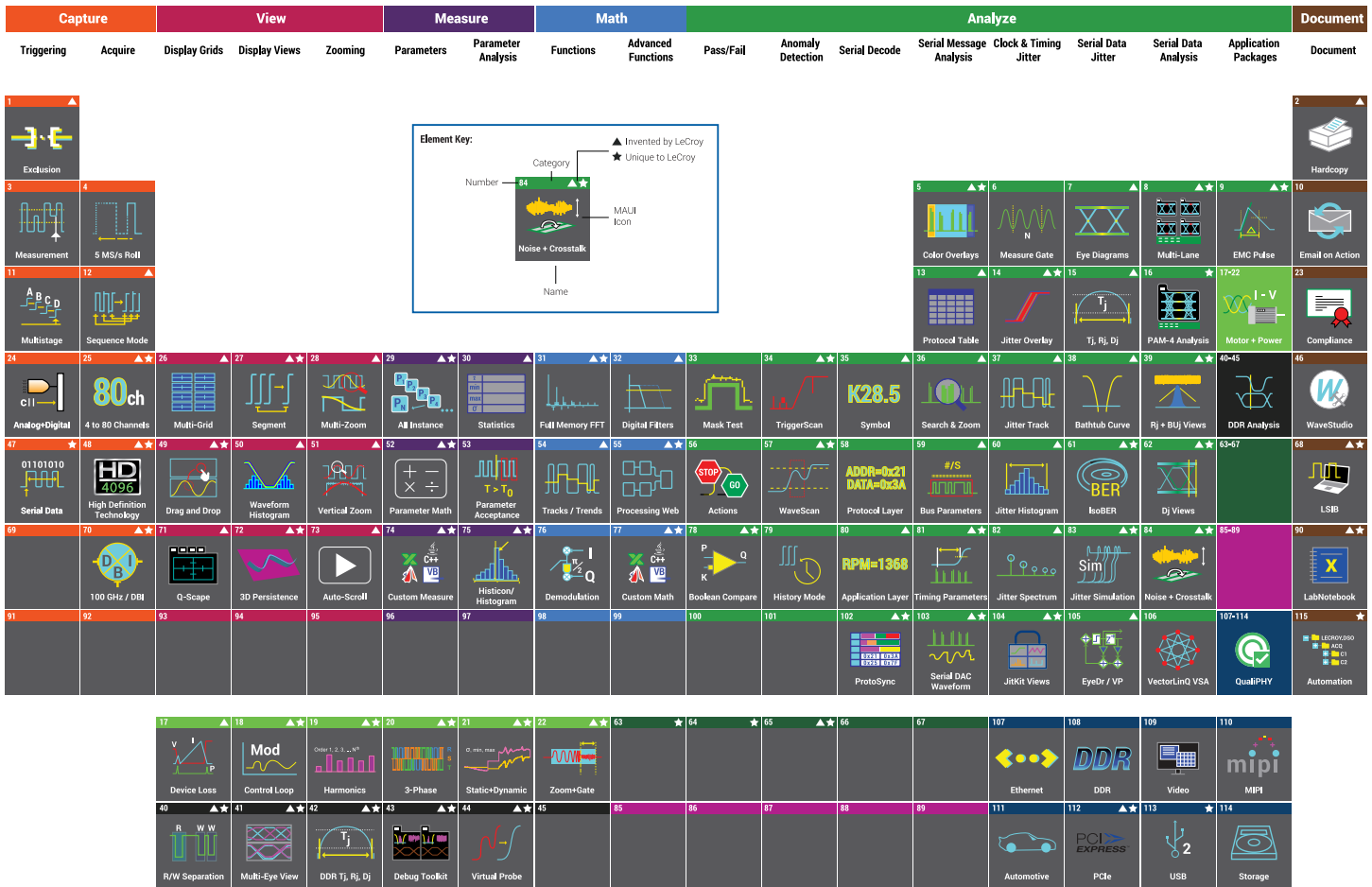

## Our heritage

Teledyne LeCroy's 50+ year heritage is in processing long records to extract meaningful insight. We invented the digital oscilloscope and many of the additional waveshape analysis tools.

## Our obsession

Our tools and operating philosophy are standardized across much of our product line. This deep toolbox inspires insight; and your moment of insight is our reward.

## Our invitation

Our Periodic Table of Oscilloscope Tools explains the toolsets that Teledyne LeCroy has deployed in our oscilloscopes. Visit our interactive website to learn more about them.

[teledynelecroy.com/tools](http://teledynelecroy.com/tools)

WaveRunner 8000 HD

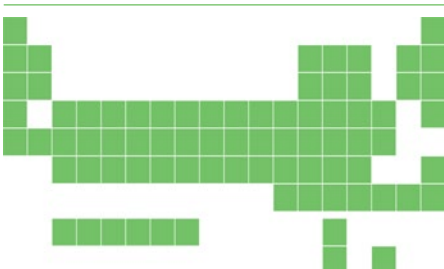

Competitor

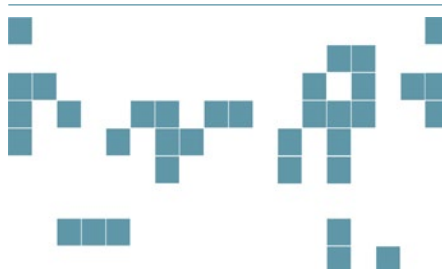

## Teledyne LeCroy offers an extensive range of probes to meet virtually every probing need.

### ZS Series High Impedance Active Probes

ZS1000, ZS1000-QUADPAK  
ZS1500, ZS1500-QUADPAK



High input impedance (1 MΩ), low 0.9 pF input capacitance and an extensive set of probe tips and ground accessories make these low-cost, single-ended probes ideal for a wide range of applications. The ZS Series is available up to 4 GHz bandwidth.

### Differential Probes (200 MHz – 1.5 GHz)

ZD1500, ZD1000,  
ZD500, ZD200  
AP033



High bandwidth, excellent common-mode rejection ratio (CMRR) and low noise make these active differential probes ideal for applications such as automotive electronics and data communications. AP033 provides 10x gain for high-sensitivity measurement of series/shunt resistor voltages.

### Active Voltage/Power Rail Probe

RP4030



Specifically designed to probe a low impedance power/voltage rail. The RP4030 has 30 V built-in offset adjust, low attenuation (noise), and high DC input impedance with 4 GHz of bandwidth. Featuring a wide assortment of tips and leads, including solder-in and U.FL receptacle connections.

### High Voltage Fiber Optically Isolated Probe

HVFO103



The HVFO103 is a compact, simple, affordable probe for measurement of small signals (gate drives, sensors, etc.) floating on an HV bus in power electronics designs, or for EMC, EFT, ESD and RF immunity testing sensor monitoring. Suitable for up to 35 kV common-mode. 140 dB CMRR.

### HVD Series High Voltage Differential Probes

HVD3102A, HVD3106A(1 kV)  
HVD3206A (2 kV)  
HVD3605A (6 kV)



Available with 1, 2 or 6 kV common-mode ratings. Excellent CMRR (65 dB @ 1 MHz) at high frequencies is combined with low inherent noise, wide differential voltage range, high offset voltage capabilities, and 1% gain accuracy. The ideal probe for power conversion system test.

### High Voltage Passive Probes

HVP120,  
PPE4KV, PPE5KV, PPE6KV



The HVP and PPE series includes four fixed-attenuation probes covering a range from 1 kV to 6 kV. These probes are ideal for lightning/surge or EFT testing, or for probing in-circuit beyond the range of an LV-rated passive probe.

### Current Probes

CP030, CP030-3M, CP030A  
CP031, CP031A  
CP150, CP150-6M  
CP500, DCS025



Available in bandwidths up to 100 MHz with peak currents of 700 A and sensitivities to 1 mA/div. Extra-long cables (3 or 6 meters) available on some models. Ideal for component or power conversion system input/output measurements. DCS015 deskew calibration source also available.

### Probe and Current Sensor Adapters

TPA10, CA10, CA10-QUADPAK



TPA10 adapts supported Tektronix TekProbe-compatible probes to the Teledyne LeCroy ProBus interface. CA10 is a programmable adapter for third-party current sensors that have voltage or current outputs proportional to measured current. QUADPAKs of four pieces each are available.

**WaveRunner 8038HD    WaveRunner 8058HD    WaveRunner 8108HD    WaveRunner 8208HD**

## Vertical - Analog Channels

Analog Bandwidth @ 50 Ω (-3 dB)	350 MHz	500 MHz	1 GHz	2 GHz
Analog Bandwidth @ 1 MΩ (-3 dB)	350 MHz	500 MHz	500 MHz	500 MHz
Rise Time (10–90%, 50 Ω)	1 ns	700 ps	400 ps	235 ps
Rise Time (20–80%, 50 Ω)	750 ps	525 ps	300 ps	176 ps
Input Channels	8			
Vertical Resolution	12 bits; up to 15 bits with enhanced resolution (ERES)			
Effective Number of Bits (ENOB)	8.9 bits	8.8 bits	8.6 bits	8.4 bits
Vertical Noise Floor (rms, 50 Ω)				
1 mV/div	95 μV	100 μV	130 μV	170 μV
2 mV/div	95 μV	100 μV	130 μV	170 μV
5 mV/div	100 μV	105 μV	135 μV	175 μV
10 mV/div	115 μV	125 μV	155 μV	200 μV
20 mV/div	130 μV	145 μV	180 μV	235 μV
50 mV/div	185 μV	200 μV	250 μV	330 μV
100 mV/div	285 μV	310 μV	390 μV	510 μV
200 mV/div	1.30 mV	1.45 mV	1.80 mV	2.35 mV
500 mV/div	1.85 mV	2.00 mV	2.50 mV	3.25 mV
1 V/div	2.95 mV	3.15 mV	4.00 mV	5.20 mV

Sensitivity	<b>50 Ω:</b> 1 mV–1 V/div, fully variable; <b>1 MΩ:</b> 1 mV–10 V/div, fully variable			
DC Vertical Gain Accuracy (Gain Component of DC Accuracy)	±(0.5%) FS, offset at 0 V			
Channel-Channel Isolation	70 dB up to 200 MHz 60 dB up to 350 MHz	70 dB up to 200 MHz 60 dB up to 500 MHz	70 dB up to 200 MHz 60 dB up to 500 MHz 50 dB up to 1 GHz	70 dB up to 200 MHz 60 dB up to 500 MHz 50 dB up to 1 GHz 40 dB up to 2 GHz

Offset Range	<b>50 Ω:</b> 1 mV to 4.95 mV: ±1.6 V, 5 mV to 9.9 mV: ±4 V 10 mV to 19.8 mV: ±8 V, 20 mV to 1 V: ±10 V <b>1 MΩ:</b> 1 mV to 4.95 mV: ±1.6 V, 5 mV to 9.9 mV: ±4 V 10 mV to 19.8 mV: ±8 V, 20 mV to 100 mV: ±16 V 102 mV to 198 mV: ±80 V, 200 mV to 1 V: ±160 V 1.02 V to 10 V: ±400 V			
--------------	---	--	--	--

DC Vertical Offset Accuracy	±(0.5% of offset value + 0.5% FS + 1 mV)			
Maximum Input Voltage	<b>50 Ω:</b> 5 Vrms, ± 10 V Peak <b>1 MΩ:</b> 400 V max. (DC + Peak AC ≤ 10 kHz)			
Input Coupling	1 MΩ: AC, DC, GND; 50 Ω: DC, GND			
Input Impedance	50 Ω ±2% or 1 MΩ    19 pF, 10 MΩ    10 pF			
Bandwidth Limiters	20 MHz, 200 MHz	20 MHz, 200 MHz, 350 MHz	20 MHz, 200 MHz, 350 MHz, 500 MHz	20 MHz, 200 MHz, 350 MHz, 500 MHz, 1 GHz
Rescaling	Length: meters, inches, feet, yards, miles; Mass: grams, slugs; Temperature: Celsius, Fahrenheit, Kelvin; Angle: radian, arcdegr, arcmin, arcsec, cycles, revolutions, turns; Velocity: m/s, in/s, ft/s, yd/s, miles/s; Acceleration: m/s <sup>2</sup> , in/s <sup>2</sup> , ft/s <sup>2</sup> , g <sub>0</sub> ; Volume: liters, cubic meters, cubic inches, cubic feet, cubic yards; Force (Weight): Newton, grain, ounce, pound; Pressure: Pascal, bar, atmosphere (technical), atmosphere (standard), torr, psi; Electrical: Volts, Amps, Watts, Volt-Amperes, Volt-Amperes reactive, Farad, Coulomb, Ohm, Siemen, Volt/meter, Coulomb/m <sup>2</sup> , Farad/meter, Siemen/meter, power factor; Magnetic: Weber, Tesla, Henry, Amp/meter, Henry/meter; Energy: Joule, BTU, calorie; Rotating Machine: radian/second, frequency, revolution/second, revolution/minute, N·m, lb-ft, lb-in, oz-in, Watt, horsepower; Other: %			

## Horizontal - Analog Channels

Timebases	Internal timebase common to 8 input channels			
Time/Division Range	100 ps/div to 5 ks/div (up to 10 ks/div with 500MPT memory, 25 ks/div with 1000MPT memory, 50 ks/div with 2000MPT memory, 100 ks/div with 5000MPT memory); Roll Mode available at ≥ 100 ms/div and ≤ 5 MS/s			
Clock Accuracy	±1 ppm + 1 ppm/year from calibration			
Sample Clock Jitter	Up to 10 μs Acquired Time Range: 80 frms (Internal Timebase Reference) Up to 10 ms Acquired Time Range: 150 frms (Internal Timebase Reference)			
Delta Time Measurement Accuracy	$\sqrt{2} * \sqrt{\left(\frac{\text{Noise}}{\text{SlewRate}}\right)^2} + (\text{Sample Clock Jitter})^2 \text{ (RMS)} + (\text{clock accuracy} * \text{reading}) \text{ (seconds)}$			
Jitter Measurement Floor	$\sqrt{\left(\frac{\text{Noise}}{\text{SlewRate}}\right)^2} + (\text{Sample Clock Jitter})^2 \text{ (RMS, seconds, TIE)}$			
Channel-Channel Deskew Range	±9 x time/div. setting, 100 ms max., each channel			
External Timebase Reference (Input)	10 MHz ±25 ppm at 0 to 10 dBm into 50 Ohms			
External Timebase Reference (Output)	10 MHz, 5.0 dBm ±2.5 dBm, sinewave synchronized to reference being used (internal or external reference)			

**WaveRunner 8038HD    WaveRunner 8058HD    WaveRunner 8108HD    WaveRunner 8208HD**

### Acquisition - Analog Channels

Sample Rate (Single-Shot)	10 GS/s on 8 Ch with Enhanced Sample Rate			
Memory Length (8 Ch / 4 Ch / 2 Ch) (Number of segments in sequence acquisition mode)	<p style="text-align: center;"><b>Standard:</b>                      50 Mpts / 100 Mpts / 200 Mpts (65,535 segments)  <b>WR8KHD-500MPT Option:</b>                      125 Mpts / 250 Mpts / 500 Mpts (65,535 segments)  <b>WR8KHD-1000MPT Option:</b>                      250 Mpts / 500 Mpts / 1000 Mpts (65,535 segments)  <b>WR8KHD-2000MPT Option:</b>                      500 Mpts / 1000 Mpts / 2000 Mpts (65,535 segments)  <b>WR8KHD-5000MPT Option:</b>                      1250 Mpts / 2500 Mpts / 5000 Mpts (65,535 segments)</p> <p style="text-align: center;">Maximum analysis memory: 500 Mpts per channel</p>			
Intersegment Time	1.5 $\mu$ s			
Averaging	Summed averaging to 1 million sweeps; continuous averaging to 1 million sweeps (waveforms of $\leq$ 500 Mpts)			
Interpolation	Linear or Sinx/x (2 pt and 5 pt) (waveforms of $\leq$ 500 Mpts)			

### Vertical, Horizontal, Acquisition - Digital Channels (WR8KHD-MSO only)

Maximum Input Frequency	500 MHz			
Minimum Detectable Pulse Width	1 ns			
Input Dynamic Range	$\pm$ 20 V			
Input Impedance (Flying Leads)	100 k $\Omega$    5 pF			
Input Channels	16 Digital Channels			
Maximum Input Voltage	$\pm$ 30 V Peak			
Minimum Input Voltage Swing	400 mV			
Threshold Groupings	Pod 2: D15 to D8, Pod 1: D7 to D0			
Threshold Selections	TTL, ECL, CMOS (2.5 V, 3.3 V, 5 V), PECL, LVDS or User Defined			
Threshold Accuracy	$\pm$ (3% of threshold setting + 100 mV)			
User Defined Threshold Range	$\pm$ 10 V in 20 mV steps			
User Defined Hysteresis Range	100 mV to 1.4 V in 100 mV steps			
Sample Rate	2.5 GS/s			
Record Length	<b>Standard:</b> 50 Mpts <b>Any memory option:</b> 500 Mpts			
Channel-to-Channel Skew	350 ps			

### Triggering System

Modes	Normal, Auto, Single, and Stop (acquisition of $\leq$ 500 Mpts) Single (acquisition of $>$ 500 Mpts)			
Sources	Any input channel, Ext, Ext/10, or Line; slope and level unique to each source (except Line)			
Coupling	DC, AC, HFRej, LFRej			
Pre-trigger Delay	0 to 100% of memory size			
Post-trigger Delay	No limitation			
Hold-off	From 1 ns up to 20 s or from 1 to 99,999,999 events			
Trigger and Interpolator Jitter	$\leq$ 2.5 ps RMS (typical), $<$ 0.1 ps RMS (typical, software assisted)			
Internal Trigger Level Range	$\pm$ 4.1 div from center (typical)			
External Trigger Level Range	Ext ( $\pm$ 0.4 V); Ext/10 ( $\pm$ 4 V)			
Maximum Trigger Rate	650,000 waveforms/second			
Trigger Sensitivity with Edge Trigger (Ch 1-8)	0.9 div @ $<$ 10 MHz 1.0 div @ $<$ 200 MHz 1.5 div @ $<$ 350 MHz	0.9 div @ $<$ 10 MHz 1.0 div @ $<$ 200 MHz 1.5 div @ $<$ 500 MHz	0.9 div @ $<$ 10 MHz 1.0 div @ $<$ 200 MHz 1.5 div @ $<$ 500 MHz 2.0 div @ $<$ 1 GHz	0.9 div @ $<$ 10 MHz 1.0 div @ $<$ 200 MHz 1.5 div @ $<$ 500 MHz 2.0 div @ $<$ 1 GHz 2.5 div @ $<$ 2 GHz
External Trigger Sensitivity, Edge Trigger	0.9 div @ $<$ 10 MHz 1.0 div @ $<$ 200 MHz 1.5 div @ $<$ 350 MHz	0.9 div @ $<$ 10 MHz 1.0 div @ $<$ 200 MHz 1.5 div @ $<$ 500 MHz	0.9 div @ $<$ 10 MHz 1.0 div @ $<$ 200 MHz 1.5 div @ $<$ 500 MHz 4.5 div @ $<$ 1 GHz	0.9 div @ $<$ 10 MHz 1.0 div @ $<$ 200 MHz 1.5 div @ $<$ 500 MHz 4.5 div @ $<$ 1 GHz
Max. Trigger Frequency, SMART Trigger	350 MHz	500 MHz	1 GHz	2.0 GHz



**WaveRunner 8038HD   WaveRunner 8058HD   WaveRunner 8108HD   WaveRunner 8208HD**

## Trigger Types

Edge	Triggers when signal meets slope (positive, negative, or either) and level condition.
Width	Triggers on positive or negative glitches with selectable widths. Minimum width: 750 ps, maximum width: 20 s
Glitch	Triggers on positive or negative glitches with selectable widths. Minimum width: 750 ps, maximum width: 20 s
Window	Triggers when signal exits a window defined by adjustable thresholds.
Pattern	Logic combination (AND, NAND, OR, NOR) of 9 inputs (8 channels and external trigger input). Each source can be high, low, or don't care. The high and low level can be selected independently. Triggers at start or end of pattern.
Runt	Trigger on positive or negative runts defined by two voltage limits and two time limits. Select between 1 ns and 20 ns.
Slew Rate	Trigger on edge rates. Select limits for dV, dt, and slope. Select edge limits between 1 ns and 20 ns.
Interval	Triggers on intervals selectable between 1 ns and 20 s.
Dropout	Triggers if signal drops out for longer than selected time between 1 ns and 20 s.
Measurement	Select from a large number of measurement parameters to trigger on a measurement value with qualified limits.
Multi-stage: Qualified	Triggers on any input source only if a defined state or edge occurred on another input source. Delay between sources is selectable by time or events.
Multi-stage: Qualified First	In Sequence acquisition mode, triggers repeatably on event B only if a defined pattern, state or edge (event A) is satisfied in the first segment of the acquisition. Holdoff between sources is selectable by time or events.

## Low Speed Serial Protocol Triggering (Optional)

I2C, I3C, SPI (SPI, SSPI, SIOP), UART-RS232, CAN1.1, CAN2.0, CAN FD, LIN, FlexRay, SENT, MIL-STD-1553, AudioBus (I2S, LJ, RJ, TDM), USB1.x/2.0, SPMI

## Measurement Tools

Measurement Functionality	Display up to 12 measurement parameters together with statistics including mean, minimum, maximum, standard deviation, and total number. Each occurrence of each parameter is measured and added to the statistics table. Histograms provide a fast, dynamic view of parameters and waveshape characteristics. Parameter math allows addition, subtraction, multiplication, or division of two different parameters. Parameter gates define the location for measurement on the source waveform. Parameter accept criteria define allowable values based on range setting or waveform state.
Measurement Parameters - Horizontal and Jitter	Cycles (number of), Delay (from trigger, 50%), Δ Delay (50%), Duty Cycle (50%, @level), Edges (number of, @level), Fall Time (90-10, @levels), Frequency (50%, @level), Half Period (@level), Hold Time (@level), N Cycle Jitter (peakpeak), Number of Points, Period (50%, @level), Δ Period (@level), Phase (@level), Rise Time (10-90, @levels), Setup (@levels), Skew (@levels), Slew Rate (@levels), Time Interval Error (@level), Time (@level), Δ Time (@level), Width (50%, @level), Δ Width (@level), X(value)@max, X(value)@min
Measurement Parameters - Vertical	Amplitude, Base, Level@X, Maximum, Mean, Median, Minimum, Peak-to-Peak, RMS, Std. Deviation, Top
Measurement Parameters - Pulse	Area, Base, Fall Time (90-10, 80-20, @levels), Overshoot (positive, negative), Rise Time (10-90, 80-20, @levels), Top, Width (50%)
Measurement Parameters - Statistical (on Histograms)	Full Width (@HalfMax, @%), Amplitude, Base, Peak@MaxPopulation, Maximum, Mean, Median, Minimum, Mode, Range, RMS, Std. Deviation, Top, X(value)@Peak, Peaks (number of), Percentile, Population (@bin, total)

## Math Tools

Math Functionality	Display up to 12 math functions traces (F1-F12). The easy-to-use graphical interface simplifies setup of up to two operations on each function trace, and function traces can be chained together to perform math-on-math.
Math Operators - Basic Math	Average (summed), Average (continuous), Difference (-), Envelope, Floor, Invert (negate), Product (x), Ratio (/), Reciprocal, Rescale (with units), Roof, Sum (+)
Math Operators - Digital (incl. with MSO option)	Digital AND, Digital DFlipFlop, Digital NAND, Digital NOR, Digital NOT, Digital OR, Digital XOR
Math Operators - Filters	Enhanced Resolution (ERes) to 15 bits vertical, Interpolate (cubic, quadratic, sinx/x)
Math Operators - Frequency Analysis	FFT (power spectrum, magnitude, phase, power density, real, imaginary, magnitude squared) up to full analysis memory length. Select from Rectangular, VonHann, Hamming, FlatTop and Blackman Harris windows.
Math Operators - Functions	Absolute value, Correlation (two waveforms), Derivative, Deskew (resample), Exp (base e), Exp (base 10), Integral, Invert (negate), Log (base e), Log (base 10), Reciprocal, Rescale (with units), Square, Square Root, Zoom (identity)
Math Operators - Other	Segment, Sparse

## Measurement and Math Integration

Histogram of statistical distributions of up to 2 billion measurements. Trend (datalog) of up to 1 million measurements. Track (measurement vs. time, time-correlated to acquisitions) of any parameter. Persistence histogram and persistence trace (mean, range, sigma).

## Pass/Fail Testing

Display up to 12 Pass/Fail queries using a Single or Dual Parameter Comparison (compare All values, or Any value <, ≤, =, >, ≥, within limit ±Δ value or %) or Mask Test (pre-defined or user-defined mask, waveform All In, All Out, Any In, or Any Out conditions). Combine queries into a boolean expression to Pass or Fail IF "All True", "All False", "Any True", "Any False", or groups of "All" or "Any", with following THEN Save (waveforms), Stop (test), (sound) Alarm, (send) Pulse, (save) LabNotebook or other User(-defined) Action.

**WaveRunner 8038HD    WaveRunner 8058HD    WaveRunner 8108HD    WaveRunner 8208HD**

## Display System

Size	Color 15.6" widescreen capacitive touch screen
Resolution	Full HD (1920 x 1080 pixels)
Number of Traces	Display a maximum of 40 traces. Simultaneously display channel, zoom, memory and math traces.
Grid Styles	Auto, Single, Dual, Triplex, Quad, Octal, Tandem, Triad, Quattro, Twelve, Sixteen, Twenty, X-Y, Single+X-Y, Dual+X-Y. Supports Normal Display Mode (1 grid style, selectable) or Q-Scape Display Mode (4 different tabs, each with individually selectable grid styles). Q-Scape tabbed displays may be viewed in Single, Dual, or Mosaic mode.
Waveform Representation	Sample dots joined, or sample dots only

## Processor/CPU

Type	Intel® Core i5-6500 Quad Core, 3.2 GHz (or better)
Processor Memory	16 GB standard
Operating System	Microsoft Windows® 10
Real Time Clock	Date and time displayed with waveform in hardcopy files. SNTP support to synchronize to precision internal clocks.

## Connectivity

Ethernet Port	2 x 10/100/1000BaseT Ethernet interface (RJ45 port)
USB Host Ports	4 side USB 3.1 Gen1 ports, 2 front USB 3.1 Gen1 ports
USB Device Port	1 USBTMC over USB 3.1 Gen1 port
GPIB Port (Optional)	Supports IEEE-488.2 (External)
External Monitor Port	1 x DisplayPort, supports up to 4096x2304 @ 24 Hz 1 x HDMI, supports up to 4096x2304 @ 60 Hz
Remote Control	Microsoft COM Automation or LeCroy Remote Command Set
Network Communication Standard	VICP or VXI-11, LXI Compatible

## Power Requirements

Voltage	90 to 264 Vrms, 47 to 63 Hz 90 to 132 Vrms, 380 to 420 Hz
Nominal Power Consumption	400 W / 400 VA
Max Power Consumption	500 W / 500 VA

## Environmental

Temperature (Operating)	+5 °C to +40 °C
Temperature (Non-Operating)	-20 °C to +60 °C
Humidity (Operating)	5% to 90% relative humidity (non-condensing) up to +31 °C Upper limit derates to 50% relative humidity (non-condensing) at +40 °C
Humidity (Non-Operating)	5% to 95% relative humidity (non-condensing) as tested per MIL-PRF-28800F
Altitude (Operating)	Up to 10,000 ft (3048 m) at or below +30 °C
Altitude (Non-Operating)	Up to 40,000 ft (12,192 m)
Random Vibration (Operating)	0.31 grms 5 Hz to 500 Hz, 20 minutes in each of three orthogonal axes
Random Vibration (Non-Operating)	2.4 grms 5 Hz to 500 Hz, 15 minutes in each of three orthogonal axes
Functional Shock	30 g peak, half sine, 11 ms pulse, 3 shocks (positive and negative) in each of three orthogonal axes, 18 shocks total

## Size and Weight

Dimensions (HWD)	13.6" H x 17.5" W x 7.7" D (345 mm x 445 mm x 196 mm)
Weight	24.4 lbs (11.1kg)

## Certifications

CE Certification	CE compliant, UL and cUL listed; conforms to UL 61010-1 (3rd Edition), UL 61010-2-030 (1st Edition)
UL and cUL Listing	CAN/CSA C22.2 No. 61010-1-12

## Warranty and Service

3-year warranty; calibration recommended annually. Optional service programs include extended warranty, upgrades, and calibration services.

Product Description	Product Code
<b>WaveRunner 8000HD Oscilloscopes</b>	
350 MHz, 8 Ch, 12 Bits, 10 GS/s, 50 Mpts/Ch High Definition Oscilloscope with 15.6" 1920x1080 capacitive touch screen and UHD (4K) extended desktop	WaveRunner 8038HD
500 MHz, 8 Ch, 12 Bits, 10 GS/s, 50 Mpts/Ch High Definition Oscilloscope with 15.6" 1920x1080 capacitive touch screen and UHD (4K) extended desktop	WaveRunner 8058HD
1 GHz, 8 Ch, 12 Bits, 10 GS/s, 50 Mpts/Ch High Definition Oscilloscope with 15.6" 1920x1080 capacitive touch screen and UHD (4K) extended desktop	WaveRunner 8108HD
2 GHz, 8 Ch, 12 Bits, 10 GS/s, 50 Mpts/Ch High Definition Oscilloscope with 15.6" 1920x1080 capacitive touch screen and UHD (4K) extended desktop	WaveRunner 8208HD

### Included with Standard Configurations

±10, 500 MHz passive probe (Qty. 4), protective cover, Getting Started Guide, Microsoft Windows® 10, commercial NIST traceable calibration with certificate, power cable for the destination country, 3-year warranty

### Mixed Signal Solutions

Mixed Signal Option (incl. 16-channel digital leadset, 22 extra large gripper probes, 20 ground extenders, 5 flexible ground leads and license)	WR8KHD-MSO
MSO License (without accessories)	WR8KHD-MSO-LICENSE

### Memory Upgrade Options

500 Mpt/2 Ch (250 Mpt/4 Ch, 125 Mpt/8 Ch)	WR8KHD-500MPT
1 Gpt/2 Ch (500 Mpt/4 Ch, 250 Mpt/8 Ch)	WR8KHD-1000MPT
2 Gpt/2 Ch (1 Gpt/4 Ch, 500 Mpt/8 Ch)	WR8KHD-2000MPT
5 Gpt/2 Ch (2.5 Gpt/4 Ch, 1.25 Gpt/8 Ch)	WR8KHD-5000MPT

### CPU, Computer and Other Hardware Options

Additional Standard Solid State Drive	WR8KHD-RSSD-02
16 GB to 32 GB CPU RAM Upgrade*	WR8KHD-UPG-32GBRAM

\* 32 GB RAM upgrade is included with all memory upgrade options.

### Oscilloscope Synchronization Options

16-Channel OscilloSYNC Software (combine two WaveRunner/MDA 8000HD oscilloscopes)	WR8KHD-16CH-SYNCH
--	-------------------

### Serial Trigger and Decode Options

MIL-STD-1553 Trigger & Decode	WR8KHD-1553 TD
MIL-STD-1553 Trigger, Decode, Measure/Graph & Eye Diagram	WR8KHD-1553 TDME
8b10b Decode	WR8KHD-8B10B D
ARINC 429 Symbolic Decode	WR8KHD-ARINC429BUS D SYMBOLIC
ARINC 429 Symbolic Decode, Measure/Graph & Eye Diagram	WR8KHD-ARINC429BUS DME SYMBOLIC
AudioBus Trigger & Decode	WR8KHD-AUDIOBUS TD
AudioBus Trigger, Decode & Graph	WR8KHD-AUDIOBUS TDG
CAN FD Trigger & Decode	WR8KHD-CAN FDBUS TD
CAN FD Trigger, Decode, Measure/Graph & Eye Diagram	WR8KHD-CAN FDBUS TDME
CAN FD Symbolic Trigger, Decode, Measure/Graph & Eye Diagram	WR8KHD-CAN FDBUS TDME SYMBOLIC

Product Description	Product Code
---------------------	--------------

### Serial Trigger and Decode Options (cont'd)

CAN Trigger & Decode	WR8KHD-CANBUS TD
CAN Trigger, Decode, Measure/Graph & Eye Diagram	WR8KHD-CANBUS TDME
CAN Symbolic Trigger, Decode, Measure/Graph & Eye Diagram	WR8KHD-CANBUS TDME SYMBOLIC
DigRF 3G Decode	WR8KHD-DIGRF3GBUS D
DigRF V4 Decode	WR8KHD-DIGRFV4BUS D
MIPI D-PHY CSI-2 & DSI Decode	WR8KHD-DPHYBUS D
Embedded Bundle: I2C, SPI, UART-RS232 Trigger & Decode	WR8KHD-EMB TD
Embedded Bundle: I2C, SPI, UART-RS232 Trigger, Decode, Measure/Graph & Eye Diagram	WR8KHD-EMB TDME
ENET Decode	WR8KHD-ENETBUS D
FlexRay Trigger & Decode	WR8KHD-FLEXRAYBUS TD
FlexRay Trigger, Decode, Measure/Graph & Physical Layer Tests	WR8KHD-FLEXRAYBUS TDMP
I2C Trigger & Decode	WR8KHD-I2CBUS TD
I2C Trigger, Decode, Measure/Graph & Eye Diagram	WR8KHD-I2CBUS TDME
I3C Trigger & Decode	WR8KHD-I3CBUS TD
I3C Trigger, Decode, Measure/Graph & Eye Diagram	WR8KHD-I3CBUS TDME
LIN Trigger & Decode	WR8KHD-LINBUS TD
LIN Trigger, Decode, Measure/Graph & Eye Diagram	WR8KHD-LINBUS TDME
Manchester Decode	WR8KHD-MANCHESTERBUS D
MDIO Decode	WR8KHD-MDIOBUS D
NRZ Decode	WR8KHD-NRZBUS D
SENT Trigger & Decode	WR8KHD-SENTBUS TD
SENT Trigger, Decode, Measure/Graph & Eye Diagram	WR8KHD-SENTBUS TDME
SpaceWire Decode	WR8KHD-SPACEWIREBUS D
SPI Trigger & Decode	WR8KHD-SPIBUS TD
SPI Trigger, Decode, Measure/Graph & Eye Diagram	WR8KHD-SPIBUS TDME
SPMI Decode	WR8KHD-SPMIBUS D
SPMI Trigger, Decode, Measure/Graph & Eye Diagram	WR8KHD-SPMIBUS TDME
UART-RS232 Trigger & Decode	WR8KHD-UART-RS232BUS TD
UART-RS232 Trigger, Decode, Measure/Graph & Eye Diagram	WR8KHD-UART-RS232BUS TDME
USB 2.0 Trigger & Decode	WR8KHD-USB2BUS TD
USB 2.0 Trigger, Decode, Measure/Graph & Eye Diagram	WR8KHD-USB2BUS TDME
USB 2.0 HSIC Decode	WR8vKHD-USB2-HSICBUS D

### Serial Data Compliance Test Options

QualiPHY 1000Base-T1 Compliance Software	QPHY-1000BASE-T1*
QualiPHY BroadR-Reach Software	QPHY-BROADR-REACH*
QualiPHY Ethernet 10/100/1000BT Software	QPHY-ENET*
QualiPHY MOST150 Software	QPHY-MOST150
QualiPHY MOST50 Software	QPHY-MOST50
QualiPHY USB 2.0 Software	QPHY-USB†
10/100/1000Base-T Ethernet Test Fixture	TF-ENET-B**
USB 2.0 Compliance Test Fixture	TF-USB-B

\* TF-ENET-B required † TF-USB-B required

\*\* Includes ENET-2CAB-SMA018 and ENET-2ADA-BNC5MA

### Debug Toolkit Options

100Base-T1 and 1000Base-T1 Debug Toolkit	WR8KHD-AUTO-ENET-TOOLKIT
Automotive Ethernet Breakout Test Fixture for 100Base-T1 and 1000Base-T1 Debug Toolkit	TF-AUTO-ENET

# ORDERING INFORMATION

## Product Description Product Code

### Serial Data Analysis Options

Serial Data Analysis Software (single-lane eye, jitter and noise measurements)	WR8KHD-SDAIII
Eye Doctor II Software (channel & fixture de-embedding/emulation, Tx/Rx equalization)	WR8KHD-EYEDRII
Virtual Probe Software (advanced de-embedding, emulation and virtual probing)	WR8KHD-VIRTUALPROBE
Serial Data Mask Software	WR8KHD-SDM
Cable De-Embedding Software	WR8KHD-CBL-DE-EMBED

### Power Analysis Options

Power Analyzer Software	WR8KHD-PWR
Digital Power Management Analysis Software	WR8KHD-DIG-PWR-MGMT
3-Phase Power Analysis Software	WR8KHD-THREEPHASEPOWER
3-Phase Harmonics Calculation Software (requires WR8KHD-THREEPHASEPOWER)	WR8KHD-THREEPHASEHARMONICS

### Jitter Analysis Options

JitKit Software (clock/clock-data jitter analysis with statistical, spectral and jitter overlay)	WR8KHD-JITKIT
--	---------------

### Digital Filtering Options

Digital Filter Software	WR8KHD-DFP2
-------------------------	-------------

### Other Software Options

EMC Pulse Parameter	WR8KHD-EMC
Spectrum Analyzer and Advanced FFT	WR8KHD-SPECTRUM
VectorLinQ Vector Signal Analysis	WR8KHD-VECTORLINQ
Advanced Customization	WR8KHD-XDEV

### Remote Control/Network Options

External USB2 to GPIB Adaptor	USB2-GPIB
-------------------------------	-----------

### General Accessories

WaveRunner 8000HD Rackmount Kit	WR8KHD-RACKMOUNT
Instrument Cart (with additional shelf and drawer)	OC1024-A

### Probes

Power/Voltage Rail Probe - 4 GHz bandwidth, 1.2x attenuation, $\pm 30$ V offset, $\pm 800$ mV	RP4030
High Voltage Fiber Optic Probe, 60 MHz bandwidth	HVF0103
500 MHz Passive Probe, 2.5mm, 10:1, 10 M $\Omega$	PP021
500 MHz Passive Probe, 5mm, 10:1, 10 M $\Omega$	PP025
1 GHz, 0.9 pF, 1 M $\Omega$ High Impedance Active Probe	ZS1000
Set of 4 ZS1000 Active Probes	ZS1000-QUADPAK
1.5 GHz, 0.9 pF, 1 M $\Omega$ High Impedance Active Probe	ZS1500
Set of 4 ZS1500 Active Probes	ZS1500-QUADPAK
200 MHz, 3.5 pF, 1 M $\Omega$ Active Differential Probe, $\pm 20$ V	ZD200
500 MHz, 1.0 pF Active Differential Probe, $\pm 8$ V	ZD500
1 GHz, 1.0 pF Active Differential Probe, $\pm 8$ V	ZD1000
1.5 GHz, 1.0 pF Active Differential Probe, $\pm 8$ V	ZD1500
500 MHz, Active Differential Probe ( $\div 1$ , $\div 10$ , $\div 100$ )	AP033

## Product Description Product Code

### Probes (cont'd)

30 A, 50 MHz Current Probe - AC/DC, 30 Arms, 50 A peak pulse, 1.5-meter cable	CP030
30 A, 10 MHz Current Probe - AC/DC, 30 Arms, 50 A peak pulse, 3-meter cable	CP030-3M
30 A, 50 MHz High Sensitivity Current Probe - AC/DC, 30 Arms, 50 A peak pulse, 1.5-meter cable	CP030A
30 A, 100 MHz Current Probe - AC/DC, 150 Arms, 50 A peak pulse, 1.5-meter cable	CP031
30A, 100 MHz High Sensitivity Current Probe - AC/DC, 30 Arms, 50 A peak pulse, 1.5-meter cable	CP031A
150 A, 10 MHz Current Probe - AC/DC, 150 Arms; 500 A peak pulse, 2-meter cable	CP150
150 A, 5 MHz Current Probe - AC/DC, 150 Arms, 500 A peak pulse, 6-meter cable	CP150-6M
500 A, 2 MHz Current Probe - AC/DC, 500 Arms, 700 A peak pulse, 6-meter cable	CP500
Deskew Calibration Source	DCS025
Programmable Current Sensor to ProBus Adapter (for third-party current sensors)	CA10
Set of 4 CA10 Programmable Current Sensor to ProBus Adapters (for third-party current sensors)	CA10-QUADPAK
100:1 400 MHz 50 M $\Omega$ 1 kV High Voltage Probe	HVP120
100:1 400 MHz 50 M $\Omega$ 4 kV High Voltage Probe	PPE4KV
1000:1 400 MHz 50 M $\Omega$ 5 kV High Voltage Probe	PPE5KV
1000:1 400 MHz 5 M $\Omega$ / 50 M $\Omega$ 6 kV High Voltage Probe	PPE6KV
TekProbe to ProBus Probe Adapter	TPA10
Optical-to-Electrical Converter - 500-870 nm, ProBus BNC connector	OE425
Optical-to-Electrical Converter - 950-1630 nm, ProBus BNC connector	OE455
1 kV, 25 MHz High Voltage Differential Probe	HVD3102A
1 kV, 25 MHz High Voltage Differential Probe (without tip accessories)	HVD3102A-NOACC
1 kV, 120 MHz High Voltage Differential Probe	HVD3106A
1 kV, 120 MHz High Voltage Differential Probe (without tip accessories)	HVD3106A-NOACC
1 kV, 80 MHz High Voltage Differential Probe - 6-meter cable and Auto Zero disconnect	HVD3106A-6M
2 kV, 120 MHz High Voltage Differential Probe	HVD3206A
2 kV, 80 MHz High Voltage Differential Probe - 6-meter cable and Auto Zero disconnect	HVD3206A-6M
6 kV, 100 MHz High Voltage Differential Probe	HVD3605A
700 V, 25 MHz High Voltage Differential Probe ( $\div 10$ , $\div 100$ )	AP031
7.5 GHz Low Capacitance Passive Probe ( $\div 10$ , 1 k $\Omega$ ; $\div 20$ , 500 $\Omega$ )	PP066

### Customer Service

Teledyne LeCroy oscilloscopes and probes are designed, built, and tested to ensure high reliability. In the unlikely event you experience difficulties, our digital oscilloscopes are fully warranted for three years and our probes are warranted for one year.

This warranty includes:

- No charge for return shipping
- Long-term 7-year support
- Upgrade to latest software at no charge



1-800-5-LeCroy  
teledynelecroy.com

Local sales offices are located throughout the world.  
Visit our website to find the most convenient location.

© 2019 by Teledyne LeCroy, Inc. All rights reserved. Specifications, prices, availability, and delivery subject to change without notice. Product or brand names are trademarks or requested trademarks of their respective holders.

PCI Express® is a registered trademark and/or service mark of PCI-SIG.

MATLAB® is a registered trademark of The MathWorks, Inc. All other product or brand names are trademarks or requested trademarks of their respective holders.

waverunner8000hd-ds-25sept19